



SALEMS KOMMUN

Enkelt planförfarande

## **ÄNDRING GENOM TILLÄGG TILL DETALJPLAN FÖR KV TRASTEN**

i Salem, Salems kommun, Stockholms län

**Plan nr 82-78**, tillägg till gällande detaljplan nr 82-06

dnr 2012/131

## **TYPRITNINGAR FÖR RADHUS, BILAGA TILL TILLÄGG TILL PLANBESTÄMMELSER**

Upprättad i maj 2014 av plan- och exploateringsenheten, arkitektkonsult  
Ola Ansnes och konsult Lina Kumlin, ETTTELVA Arkitekter, ej reviderad i april  
2015.

## RITNINGSFÖRTECKNING

Beteckning	Datum	Innehåll	S2	S3
K-1	2005-06-09	Takfot vinklad	x	x
K-2	2006-08-21	Takfot rak	x	x
K-3	2011-04-18	Entrétak, sadel/pulpet	x	x
K-4	2011-04-18	Förstukvist med sadeltak	x	
K-5	2011-04-18	Förstukvist med pulpettak	x	
K-6	2011-04-18	Entrétak och burspråk med pulpettak	x	x
K-7	2011-04-18	Burspråk på baksidan	x	x
K-8	2012-09-02	Balkong, raka hörn	x	x
K-9	2012-09-02	Balkong, fasade hörn	x	x
K-10	2011-04-18	Påbyggnad vind, sadeltak	x	x
K-11	2011-04-18	Påbyggnad vind, pulpettak	x	x
S2-1	2012-09-02	Inglasat uterum vid vardagsrum	x	
S2-2	2012-09-02	Inglasat uterum vid sovrum	x	
S3-1	2011-04-18	Förstukvist pulpettak		x
S3-2	2011-04-18	Förstukvist sadeltak		x
S3-3	2011-04-18	Förstukvist/burspråk med pulpettak		x
S3-4	2012-09-02	Inglasat uterum vid badrum		x
S3-5	2012-09-02	Inglasat utrum vid kök		x

För vilken hustyp som finns i respektive länga, se planbestämmelserna. Obs! ritningarnas skala kan variera något.

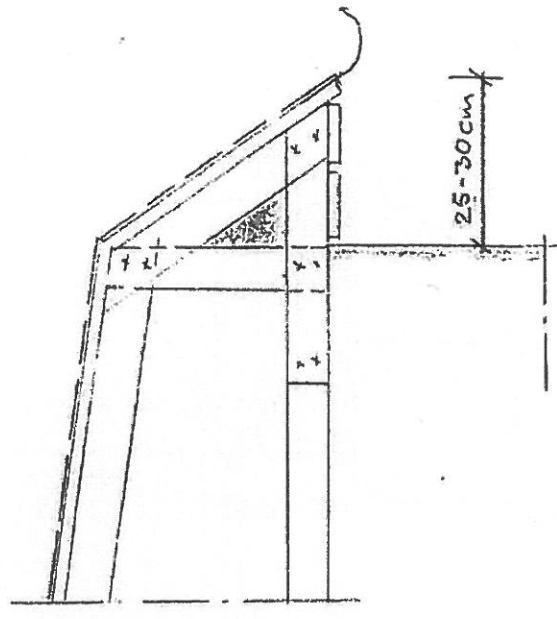
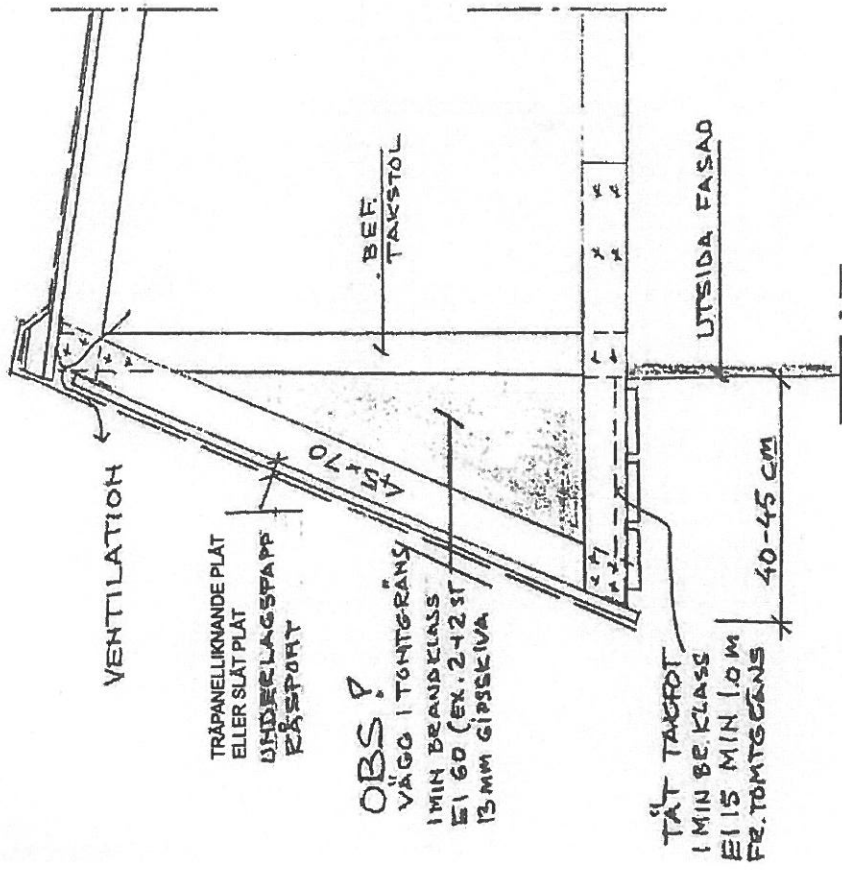

SALEM  
OMBYGGNAD AV TAKROT  
TYPSEKTIONER I SKALA 1:10  
2005-06-09

*Kjell Nilsson*  
KJELL NILSSON

K-1

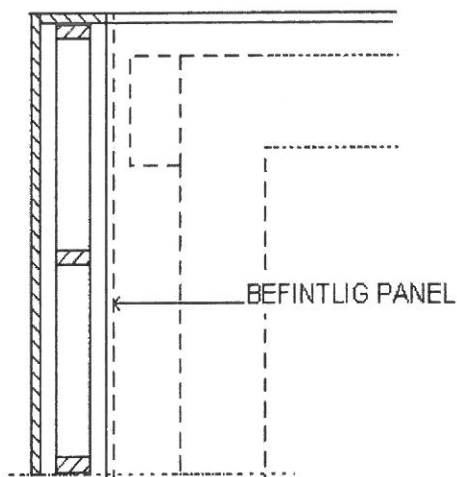
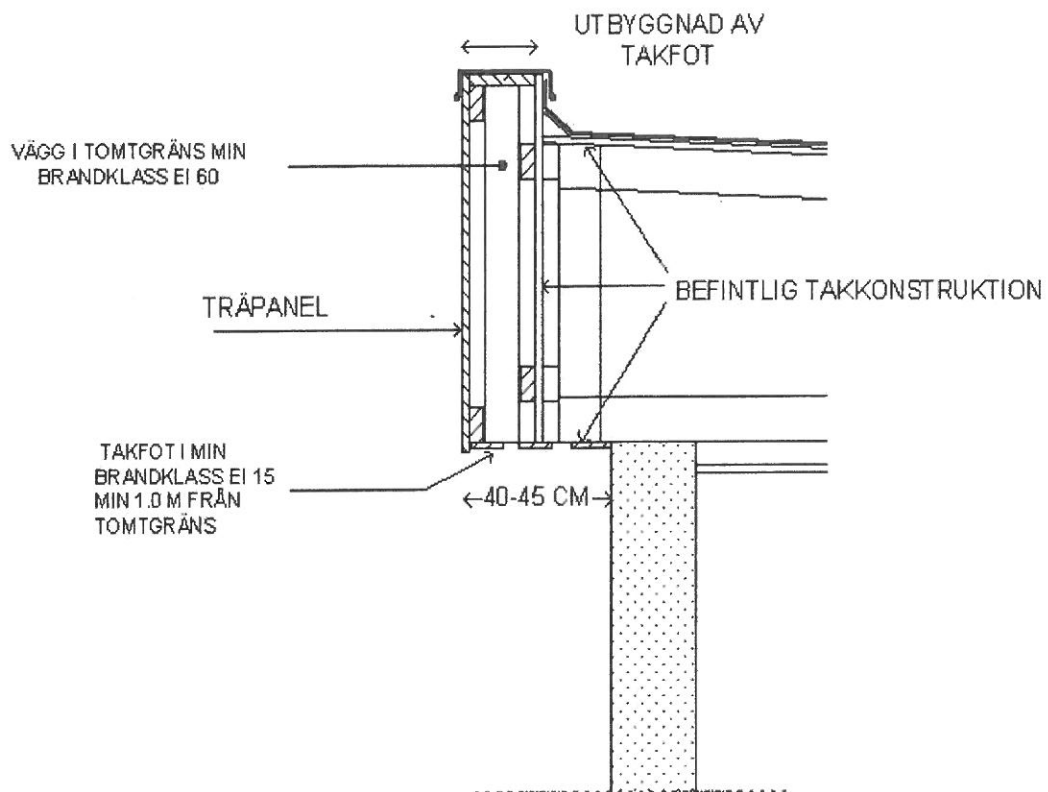

REV 2006 08 21

SALEMS KOMMUN	UTBYGGNAD TAKFOT, KEDJEHUS	
FASTIGHET ADRESS	SKALA 1.20      DATUM	K-2

SÅNGLÄRKAN

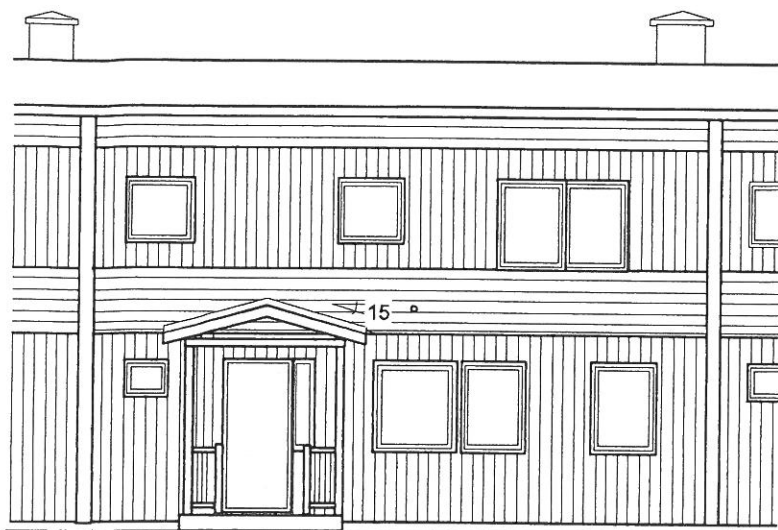
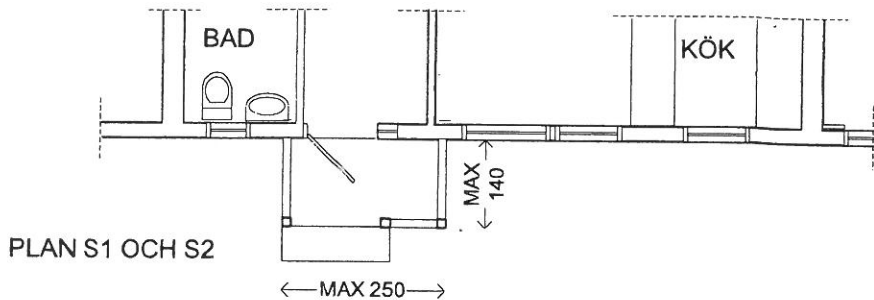

FASAD

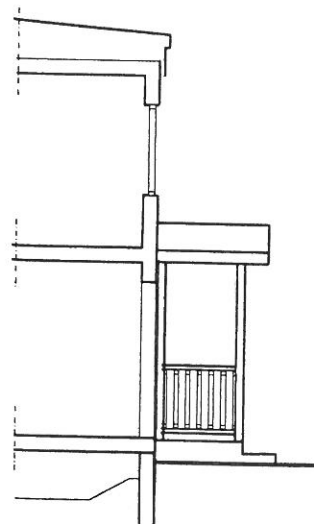

SEKTION/FASAD



FASAD

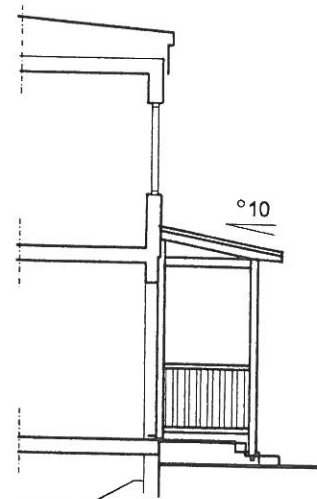

RITNGEN GÄLLER  
I PRINCIP S1, S2  
OCH S3

SKISS 20110418

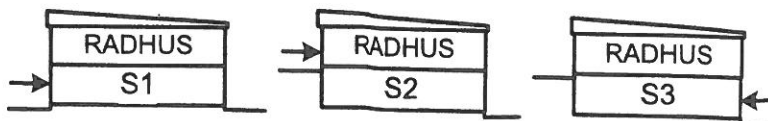

SALEMS KOMMUN

HUSTYP S1, S2 OCH S3

ENTRETAK, SADEL/  
PULPET

FASTIGHET:

PLAN, FASADER

ADRESS:

SKALA 1:100

DATUM:

K3

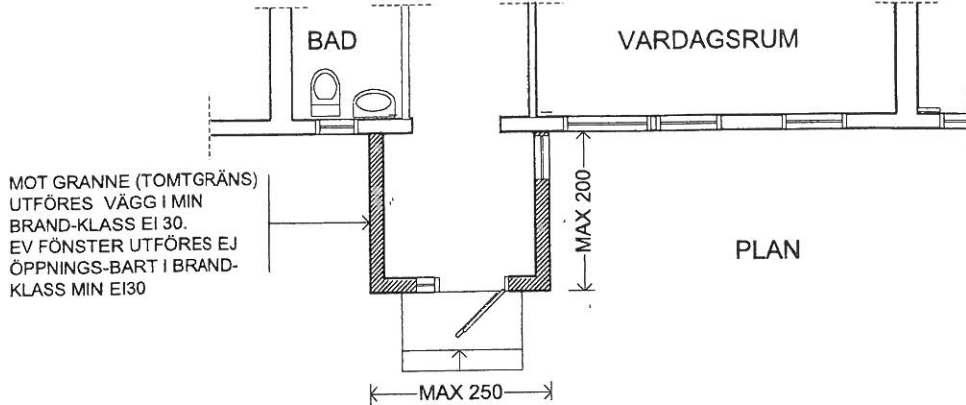

PLAN

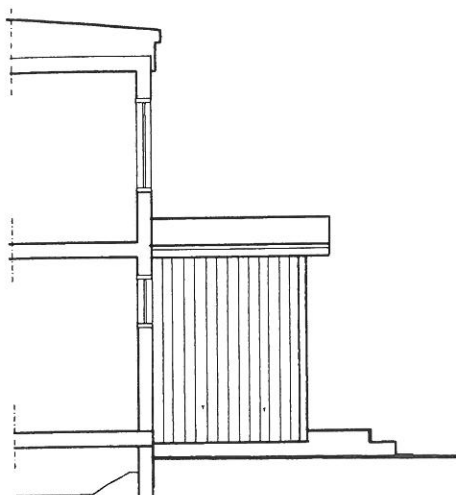

SEKTION/FASAD

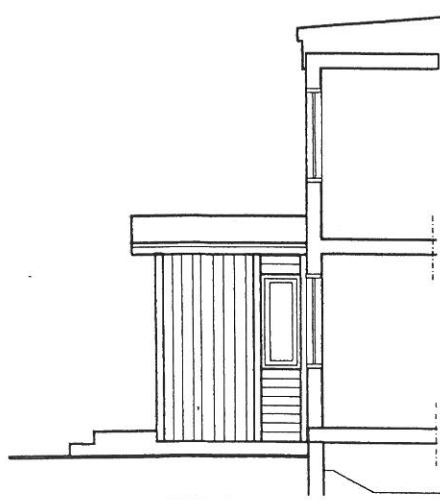

SEKTION/FASAD



FASAD

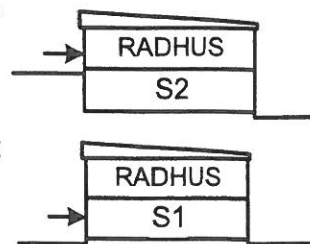

SKISS 20110418

SALEMS KOMMUN

HUSTYP S1, S2

FÖRSTUKVIST MED SADELTAK

FASTIGHET:

PLAN, FASADER

ADRESS:

SKALA 1:100

DATUM:

K4

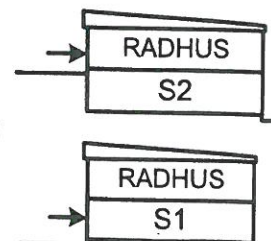
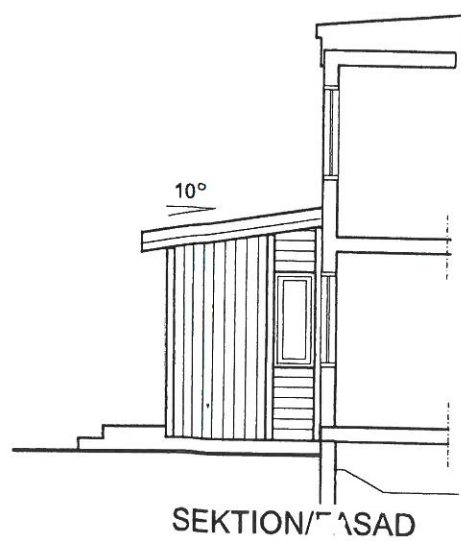
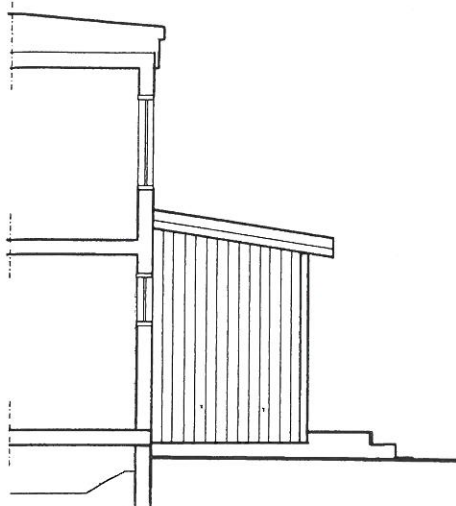
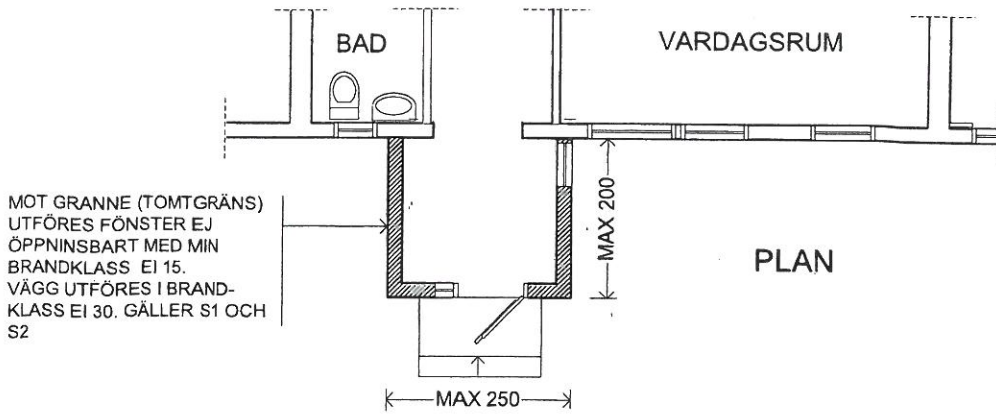

SKISS 20110418

SALEMS KOMMUN

HUSTYP S1, S2

FÖRSTUKVIST PULPETTAK

FASTIGHET:

PLAN, FASADER

ADRESS:

SKALA 1:100

DATUM:

K5

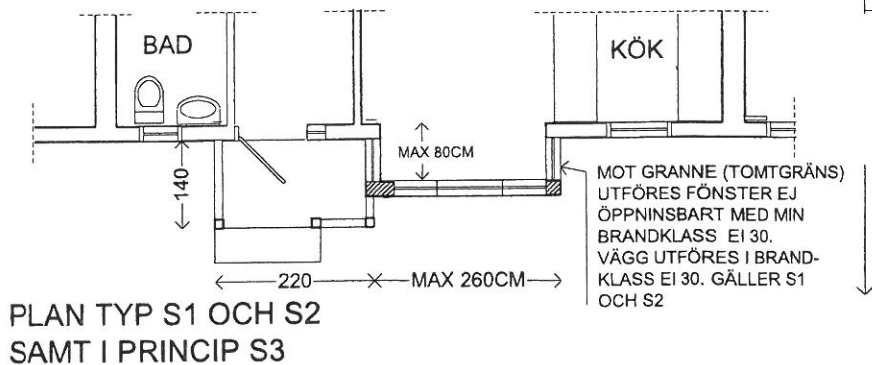

FASAD TYP S3

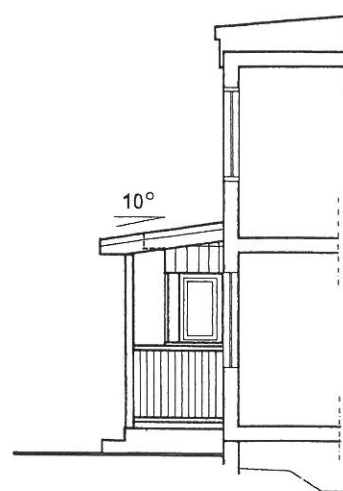

SEKTION/FASAD



FASAD TYP S1 SAMT I PRINCIP S2

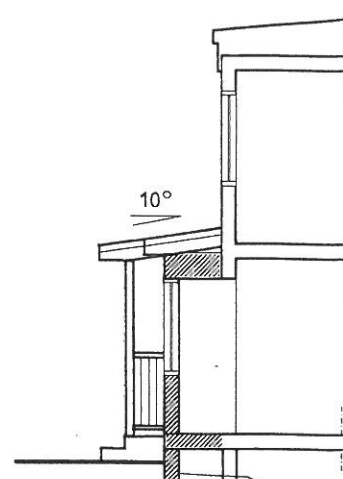

SEKTION/FASAD

SKISS 20110418

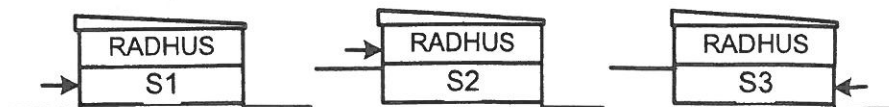

SALEMS KOMMUN

HUSTYP S1, S2, S3

ENTRETAK OCH BURSPRÄK MED  
 PULPETTAK

FASTIGHET:

PLAN, FASADER

ADRESS:

SKALA 1:100

DATUM:

K6



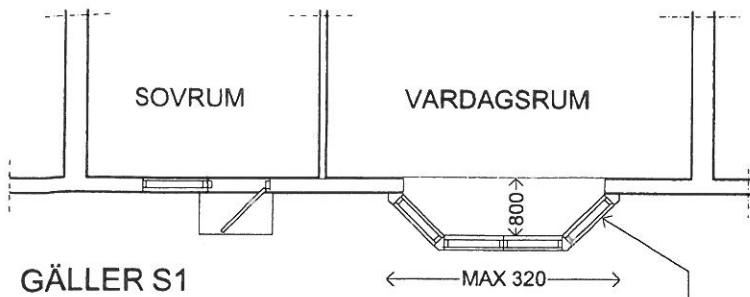

GÄLLER S1

PLAN

MOT GRANNE (TOMTGRÄNS)  
 UTFÖRS FÖNSTER EJ  
 ÖPPNINGSBART MED MIN  
 BRANDKLASS EI 15.  
 ALTERNATIVT MED TÄT VÄGG  
 MED BRANDKLASS MINST EI30

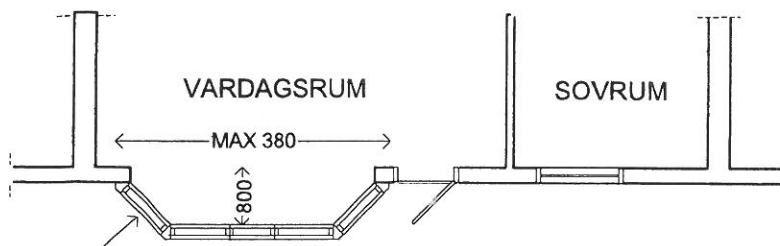

GÄLLER S2 OCH S3

MOT GRANNE (TOMTGRÄNS)  
 UTFÖRS FÖNSTER EJ  
 ÖPPNINGSBART MED MIN  
 BRANDKLASS EI 15.  
 ALTERNATIVT MED TÄT  
 VÄGG MED BRANDKLASS  
 MINST EI30

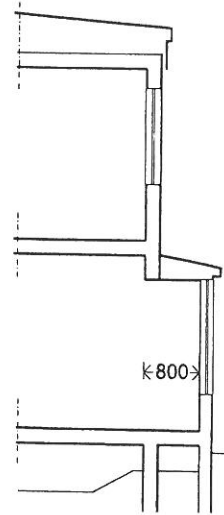

SEKTION



FASAD S1

GÄLLER I PRINCIP  
 ÄVEN S2 OCH S3

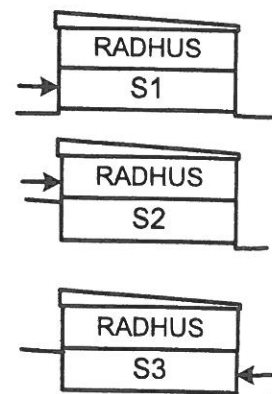

SKISS 20110418

SALEMS KOMMUN

HUSTYP S1, S2, S3

BURSPRÄK PÅ BAKSIDAN

FASTIGHET:

PLAN, FASADER

ADRESS:

SKALA 1:100

DATUM:

K7

SÅNGLÄRKAN

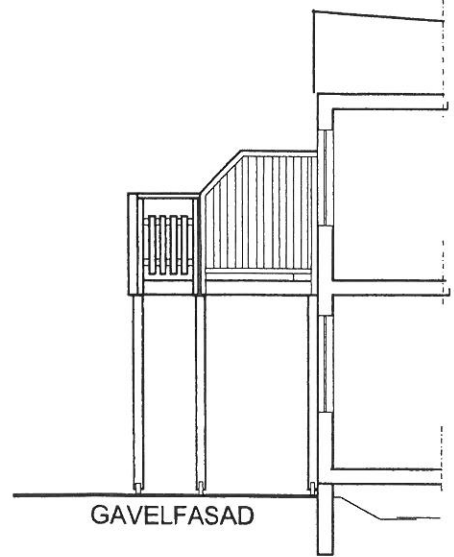
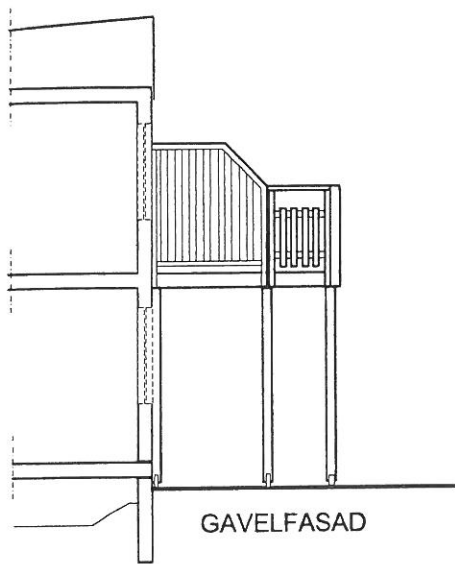
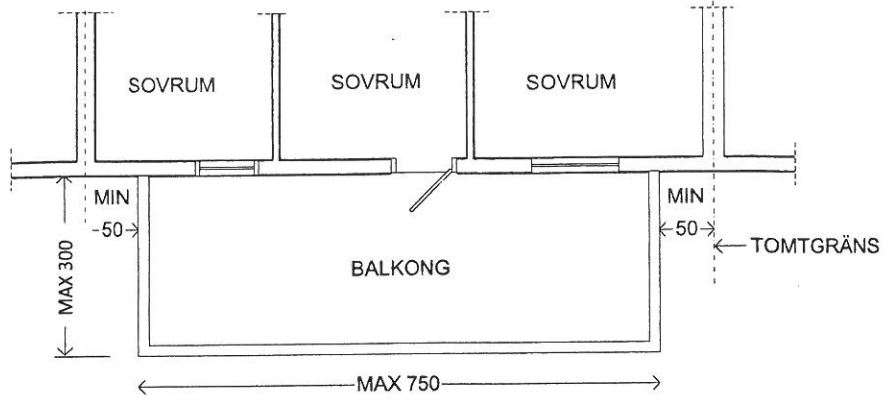

BALKONGRITNINGEN  
GÄLLER I PRINCIP ALLA  
TVÅVÅNINGS FASADER FÖR  
HUSTYP S1,S2 OCH S3

SKISS 20110418

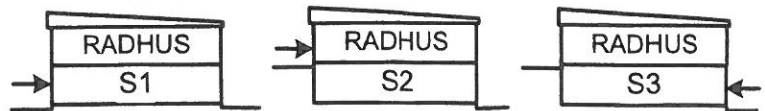

SALEMS KOMMUN

HUSTYP S1, S2, S3 BALKONG, RAKA HÖRN

FASTIGHET:  
ADRESS:

PLAN, FASADER

SKALA 1:100

DATUM:

K8

SÅNGLÄRKAN

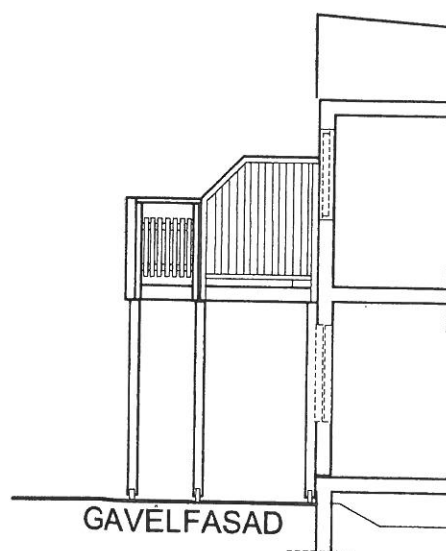
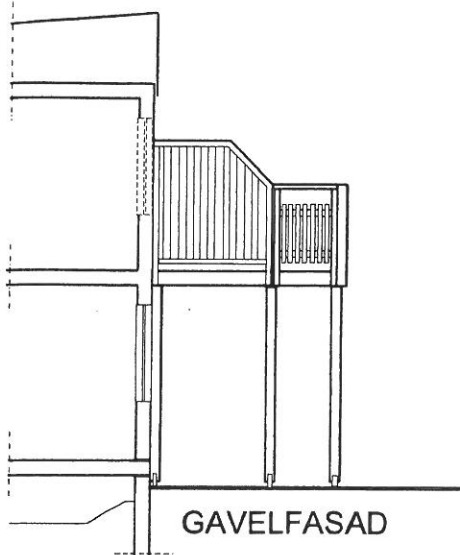
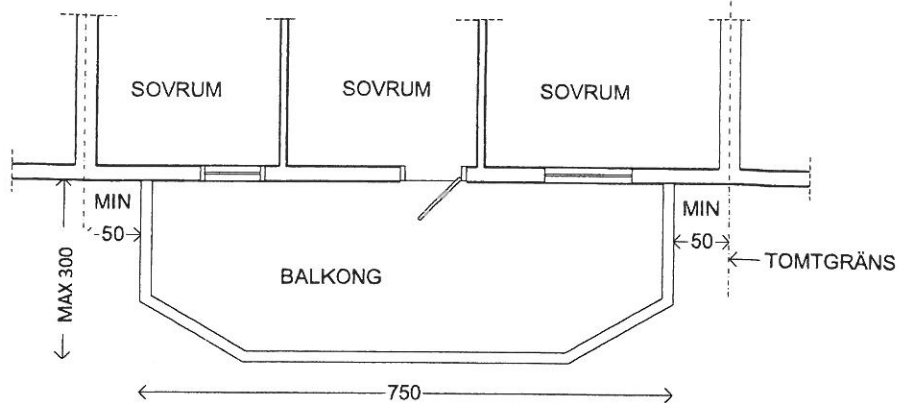

BALKONGRITNINGEN  
GÄLLER I PRINCIP ALLA  
TVÅVÅNINGS FASADER FÖR  
HUSTYP S1,S2 OCH S3

SKISS 20110418

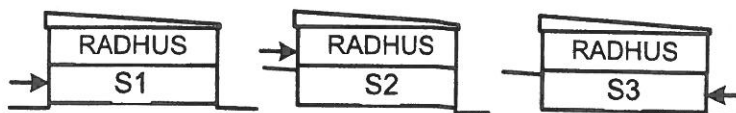

SALEMS KOMMUN

HUSTYP S1, S2, S3 BALKONG, FASADE HÖRN

FASTIGHET:

PLAN, FASADER

ADRESS:

SKALA 1:100

DATUM:

K9

SÅNGLÄRKAN

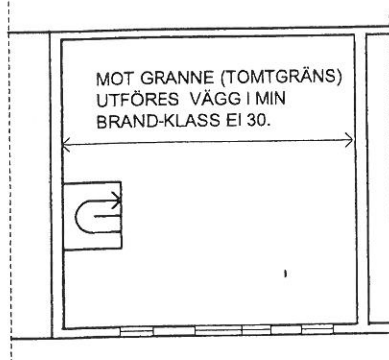

PÅBYGD VÅNINGSPÅN  
SKALA 1:200

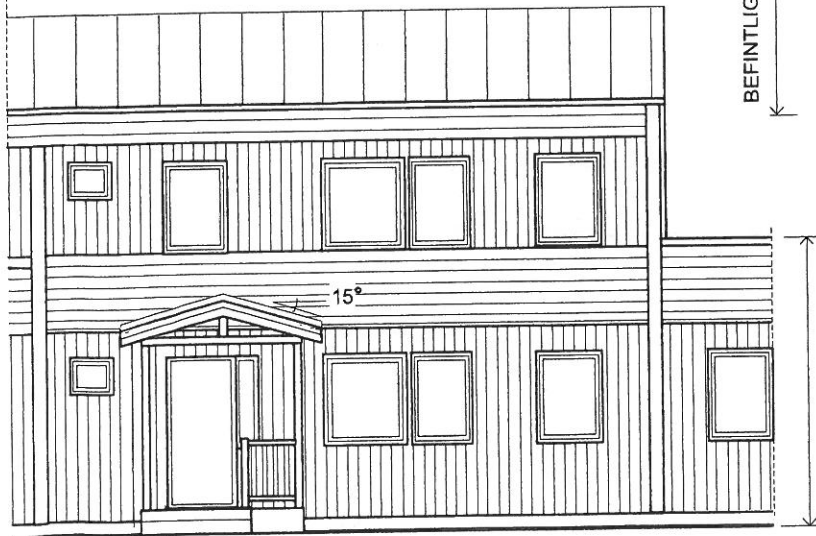
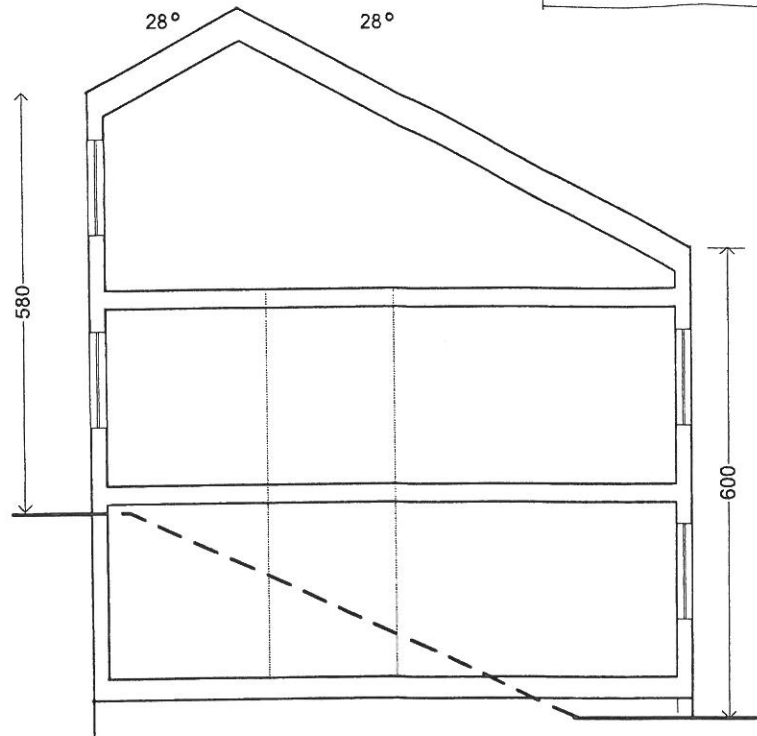

NY FASAD SKALA 1:100

SKISS 20110418

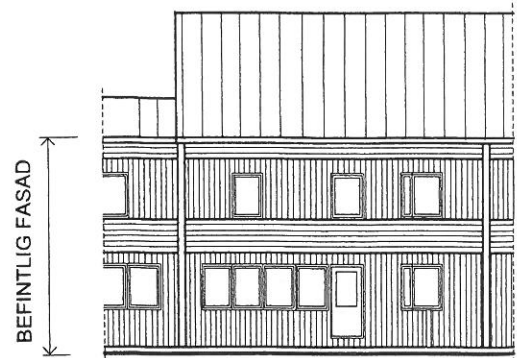

SKALA 1:200

SKISSRITNINGEN VISAR  
TYP S2 MEN GÄLLER I  
PRINCIP ÄVEN TYP S3

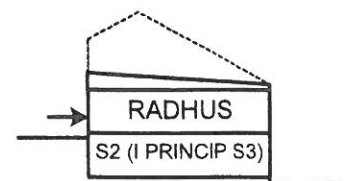

SALEMS KOMMUN

HUSTYP S2, PÅBYGGNAD VIND, SADELTAK.

FASTIGHET:

PLAN, FASADER

ADRESS:

SKALA 1:100

DATUM:

K10

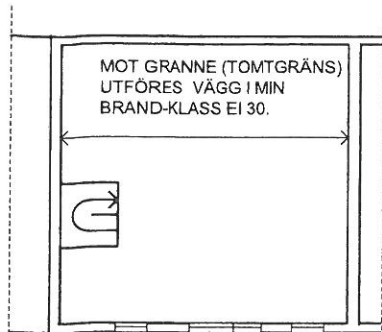

PÅBYGD VÅNINGSPÄN  
SKALA 1:200

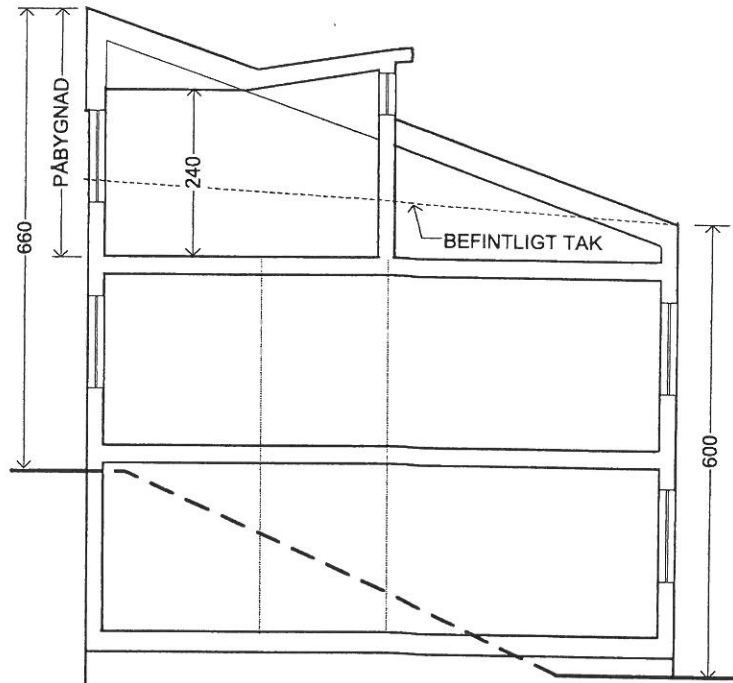

NY FASAD SKALA 1:100

BEFINTLIG FASAD

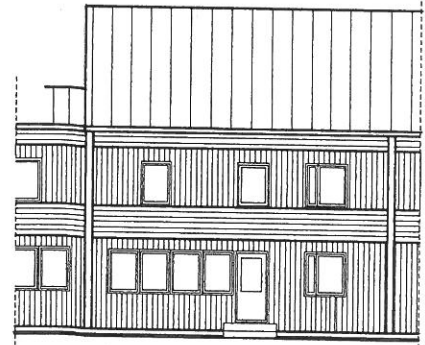

SKALA 1:200

RITNINGEN VISAR TYP S2 MEN GÄLLER I PRINCIP ÄVEN TYP S3

BEFINTLIG FASAD

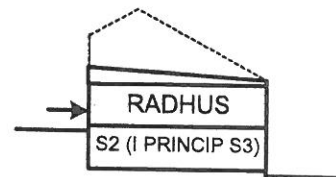

SKISS 20110418

SALEMS KOMMUN

HUSTYP S2, S3. PÅBYGGNAD VIND, PULPETTAK.

FASTIGHET:

PLAN, FASADER

ADRESS:

SKALA 1:100

DATUM:

K-11

SÅNGLÄRKAN

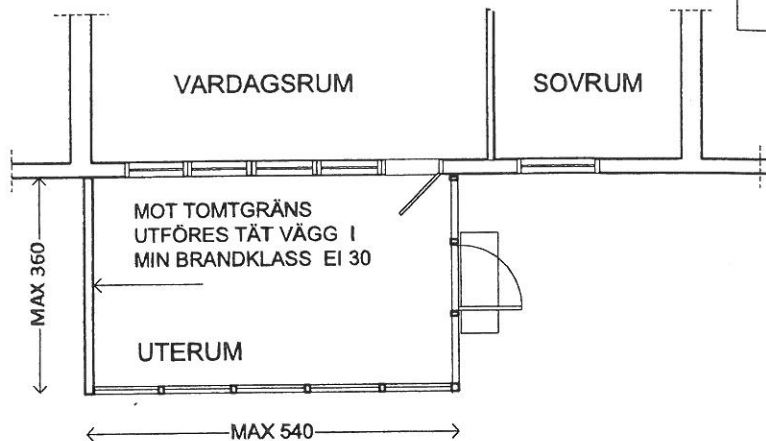

PLAN

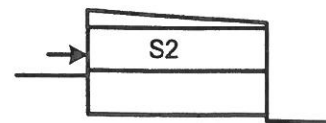
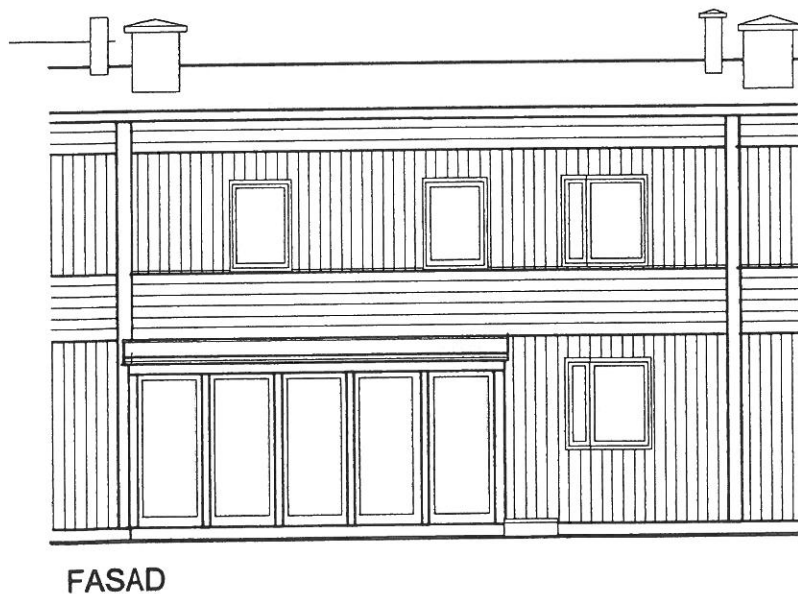
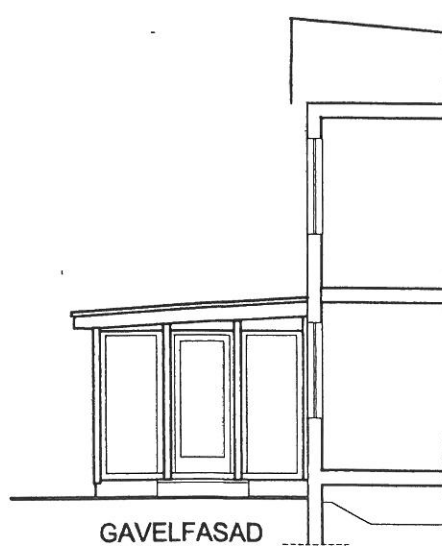
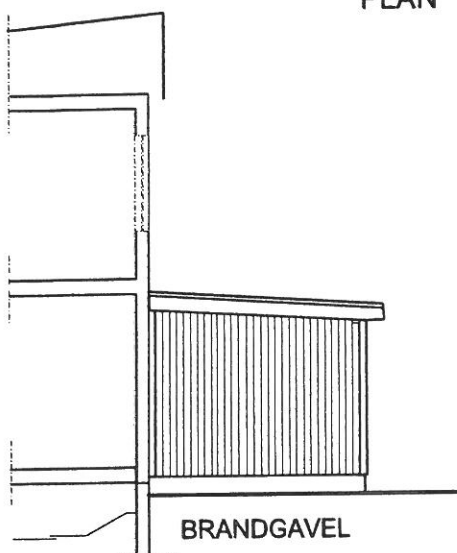

SKISS 2012015

SALEMS KOMMUN

HUSTYP S2 INGLASAT UTERUM VID VARDAGSRUM

FASTIGHET:

PLAN, FASADER

ADRESS:

SKALA 1:100

DATUM:

S2-1

SÅNGLÄRKAN

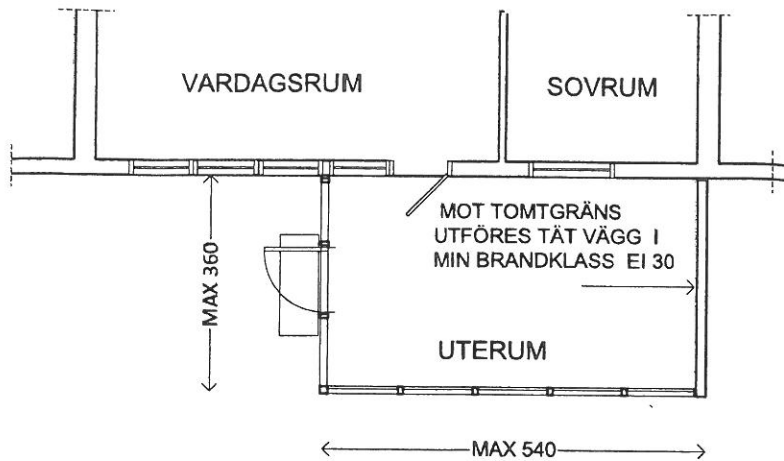

PLAN

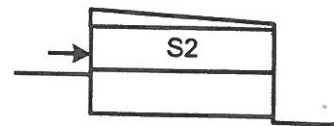
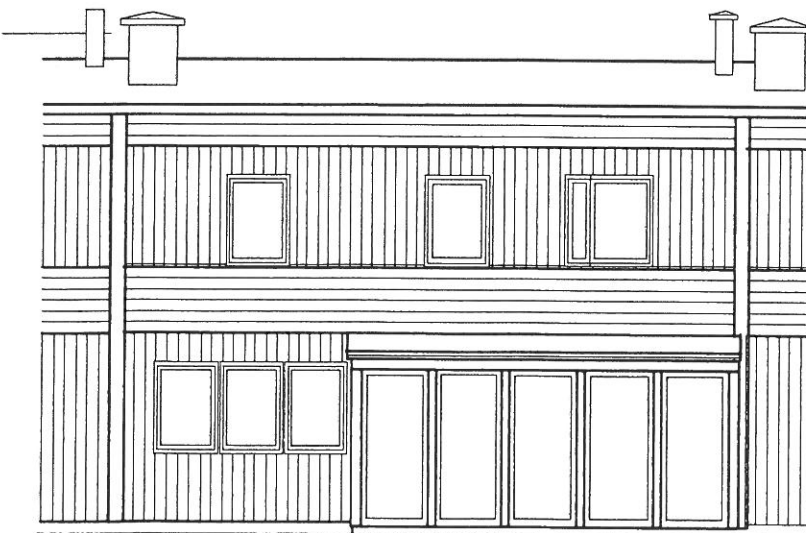
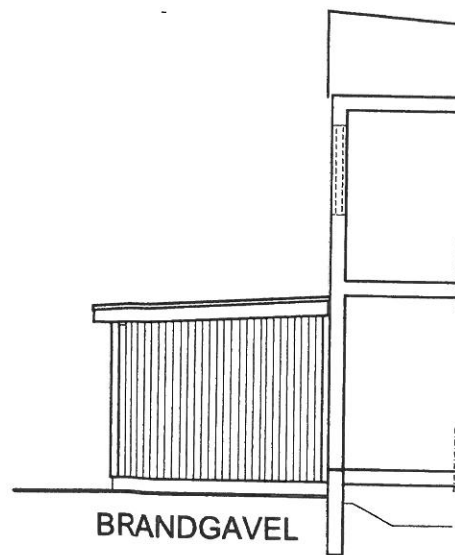
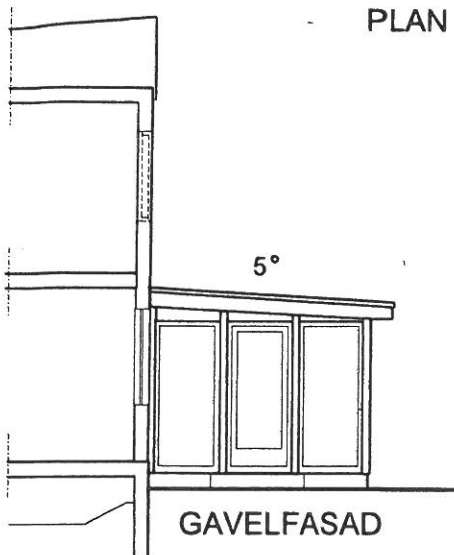

SKISS 20120315

SALEMS KOMMUN

HUSTYP S2 INGLASAT UTERUM VID SOVRUM

FASTIGHET:

PLAN, FASADER

ADRESS:

SKALA 1:100

DATUM:

S2-2

